

Fundamental Science for Performance, Cost and Durability

**Yu Seung Kim
Mike Janicke
Rob Gilbertson
Jim Boncella
Dilip Asthagiri
Lawrence Pratt
Tom Springer
Piotr Zelenay
Piotr Piela
John Davey
Mahlon Wilson
Jerzy Chlistunoff
Francisco Uribe
Bryan Pivovar (Point of Contact)**

Los Alamos National Laboratory
Institute for Hydrogen and Fuel Cell Research

May 25, 2005

This presentation does not contain any proprietary or confidential information

Overview

Timeline (New Project)

- Develop, demonstrate and validate a model for reference electrodes in a fuel cell.
Status: Complete
- Develop and validate a model explaining membrane-electrode interfacial resistance.
Status: Significant Progress (~50% complete)
- Study the effects of relative humidity on oxygen reduction.
Status: Initial Results (~20% complete)
- Investigate enabling electrolytes (higher pH proton conductors)
Status: Started (~20% complete)

Barriers Addressed

- **A. Durability**
- **B. Cost**
- **C. Electrode Performance**
- **D. Thermal, Air, and Water Management**

Total Project Funding

- Funding in FY04: \$0 K
- Funding for FY05: \$600 K
- Non-cost shared

Collaborators

- Prof. James McGrath (Virginia Polytechnic and State University)

Objectives

- **To assist the DOE Hydrogen, Fuel Cells & Infrastructure Technologies (HFCIT) Program in meeting cost, durability and performance targets by developing the fundamental understanding and the technical underpinnings of new, potentially enabling technologies .**
 - **Apply phenomenological models to the development of a robust reference electrode and the study of membrane-electrode delamination.**
 - **Investigate the effect of water activity (RH) on oxygen reduction.**
 - **Study electrolytes that can function at higher pH than currently employed ionomers (improved ORR and catalyst stability).**

Technical Approach (4 Thrusts)

- **Reference Electrodes**
 - Develop a reference electrode design for fuel cells that gives relevant and reproducible results
 - Apply phenomenological and CFD models to verify electrode design
- **Membrane-Electrode Interfacial Delamination Model**
 - Develop a phenomenological and CFD model to explain observed membrane-electrode resistance based on electrode delamination.
 - Validate model using experimental results
- **Low Relative Humidity ORR**
 - Investigate oxygen reduction reaction as a function of relative humidity as it would relate to lower humidity operation of fuel cell cathodes
 - Initial studies using platinum micro-electrodes, expand later to include other catalytic supports
- **High pH Electrolytes**
 - Explore proton conduction in imidazole ‘buffered’ electrolytes to explore proton conductivity through a range of pH.
 - Combine experimental results and observations with *ab-initio* modeling efforts.

Reference Electrodes (Thrust 1)

(Davey, Piela, Springer, Wilson, Zelenay)

- **Reference electrodes in PEM fuel cells:**

- *Rarely used because of small (assumed) overpotentials at neat hydrogen anodes, however in order to examine this overpotential or in the case of impurities (H_2S , CO , NH_3 , etc) or DMFCs where anode overpotentials can become significant; reference electrodes are required to understand the electrochemical state of each of the electrodes (important in relation to catalyst stability and durability).*
- *Problems include: complex electric field distribution in thin MEA components, large systematic errors and unreliable performance.*

- **Requirements:**

- *Electrode of constant potential with a fast red-ox process requiring only negligible flow of current through the working electrode;*
- *Contact with the same electrolyte as the working electrode (to avoid liquid/ionomer junction potential);*
- *Known (preferably small) iR -drop between the reference and working electrode, large systematic errors and unreliable performance.*

- **Approach:**

- *Explore 3 different reference electrode geometries and validate results using CFD models.*
 - “Outside Catalyst Layer” – common literature approach*
 - “Exposed Catalyst”*
 - “Electrolytic Key”*

Configuration A: "Outside Catalyst Layer"

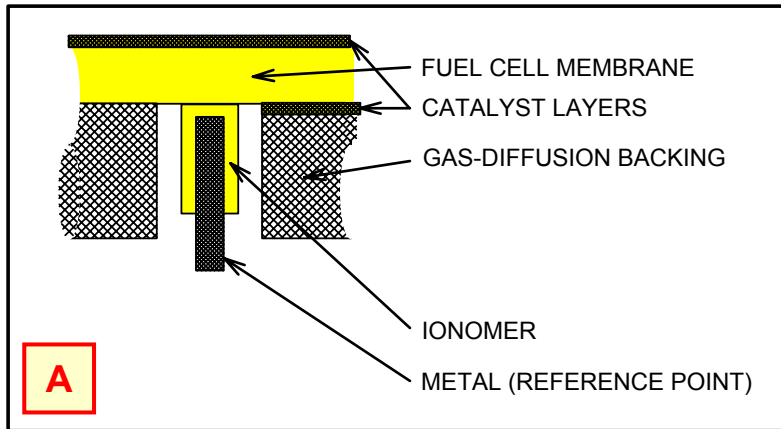

Reference electrode placed outside active catalyst layers: *Poor agreement between $(C-R_C)-(A-R_A)+(R_C-R_A)_{i=0}$ and $(C-A) + iR$ due to problems with reference electrodes.*

H₂-air: *Edge effects; R_A sensing changing cathode potential (slow kinetics); R_C working well thanks to very fast kinetics of the anode process across the membrane*

DMFC: *Both kinetics slow*

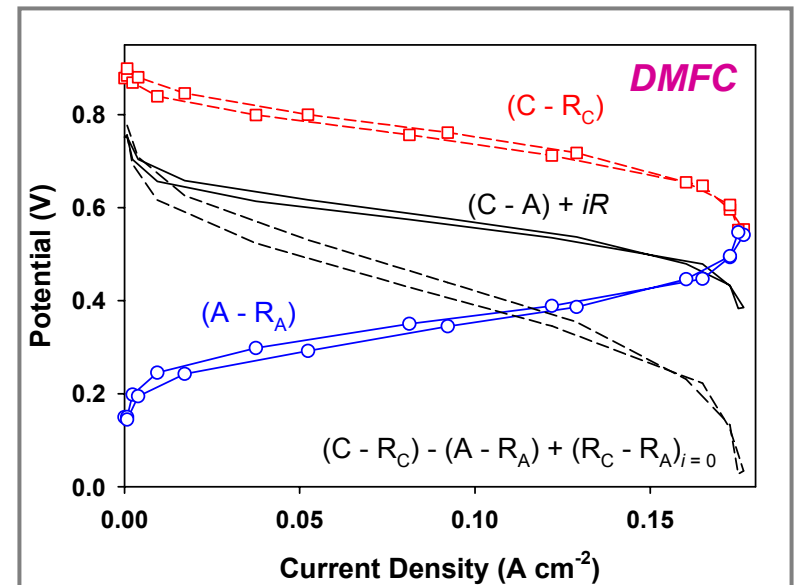
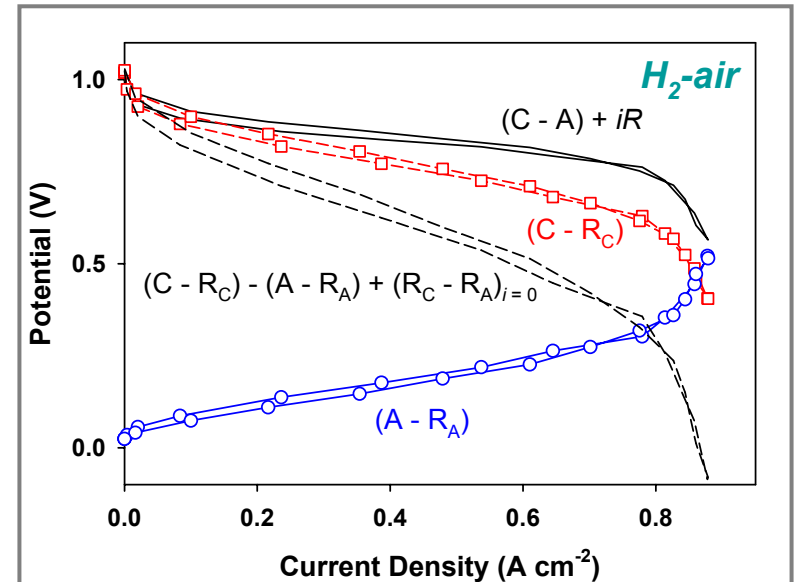

Configuration B: "Exposed Catalyst"

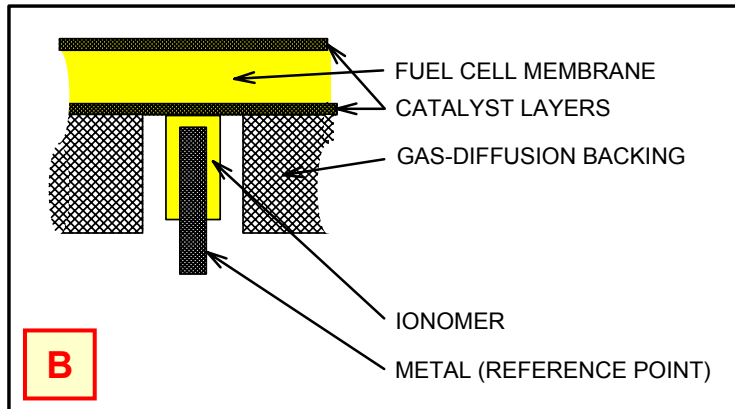

Reference electrode placed in direct contact with active catalyst layers: *Poor agreement between $(C-R_C) - (A-R_A) + (R_C - R_A)_{i=0}$ and $(C-A) + iR$ due to problems with reference electrodes.*

H₂-air & DMFC: *Data affected by iR component; little or no current generation in catalyst layers screened by reference electrodes (high iR in the metal, potential shift in the ionomer).*

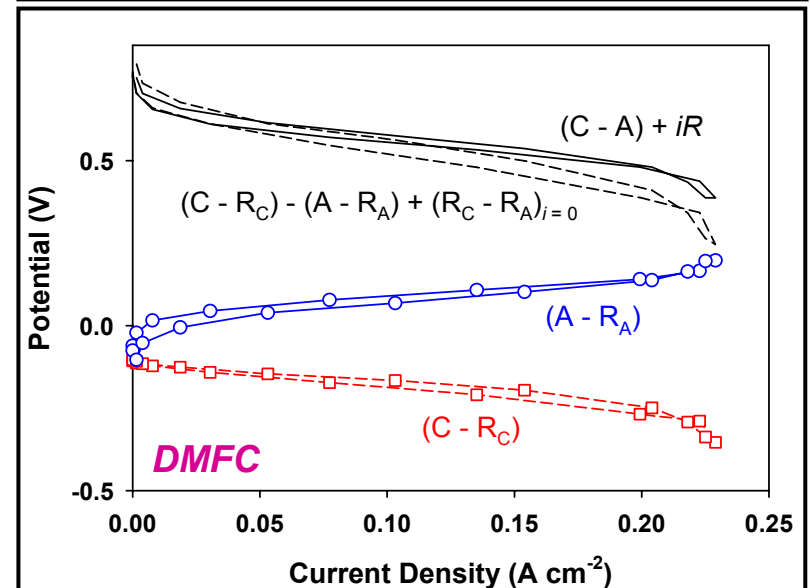
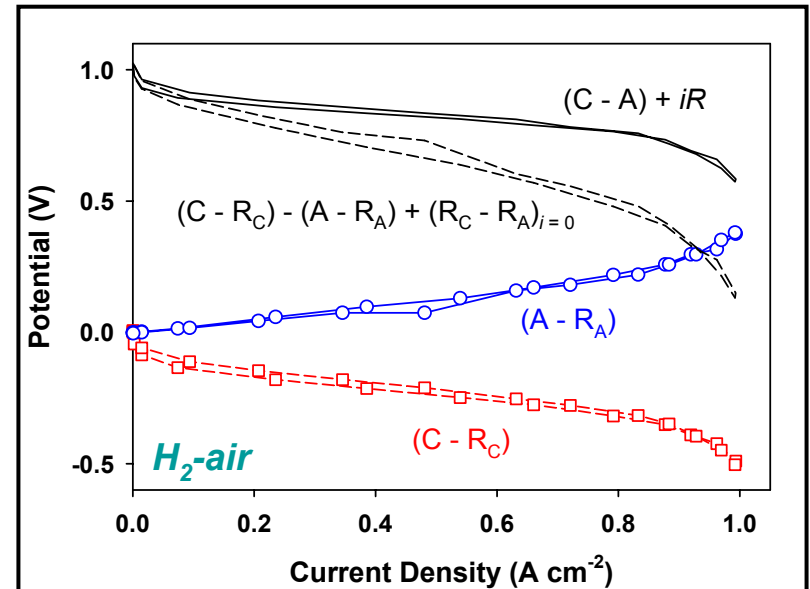

Configuration C: "Electrolytic Key"

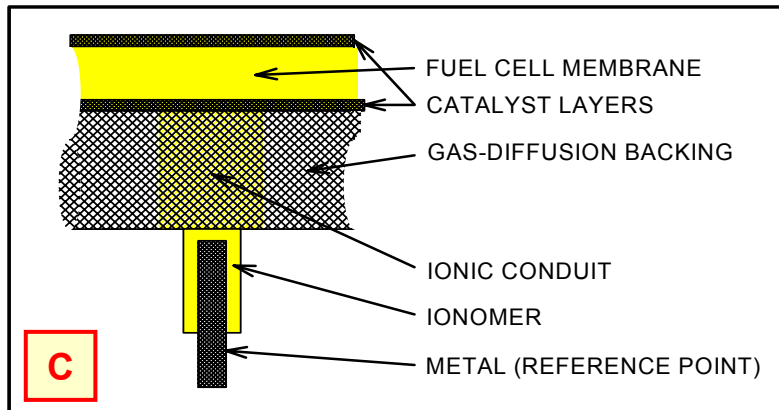

Reference electrode placed above active catalyst layers and connected ionically with Nafion through backing layer: *Good agreement between $(C-R_C) - (A-R_A) + (R_C - R_A)_{i=0}$ and $(C-A) + iR$.*

H₂-air & DMFC: *Well-performing DHE electrodes placed in the main flow path; all performance criteria met; current generation in catalyst layers directly under reference electrodes undisturbed by electrodes' presence (maintained electronic pathway).*

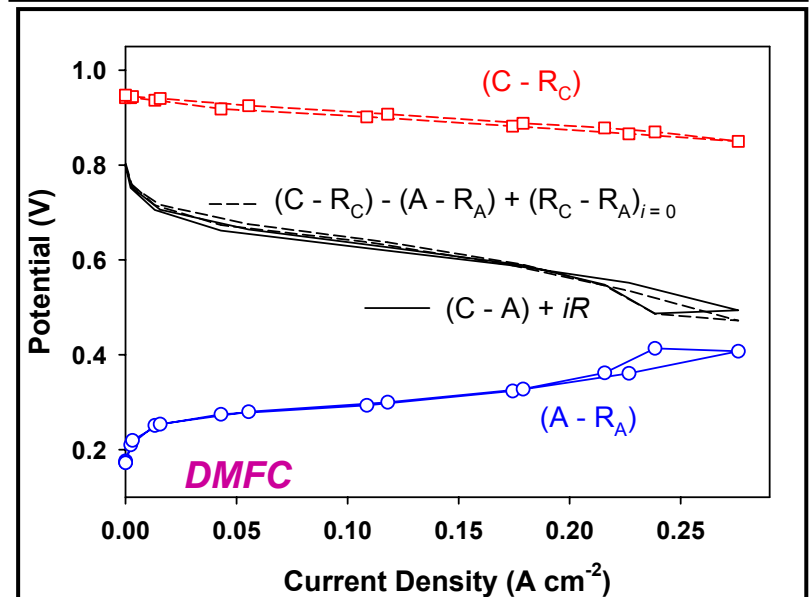
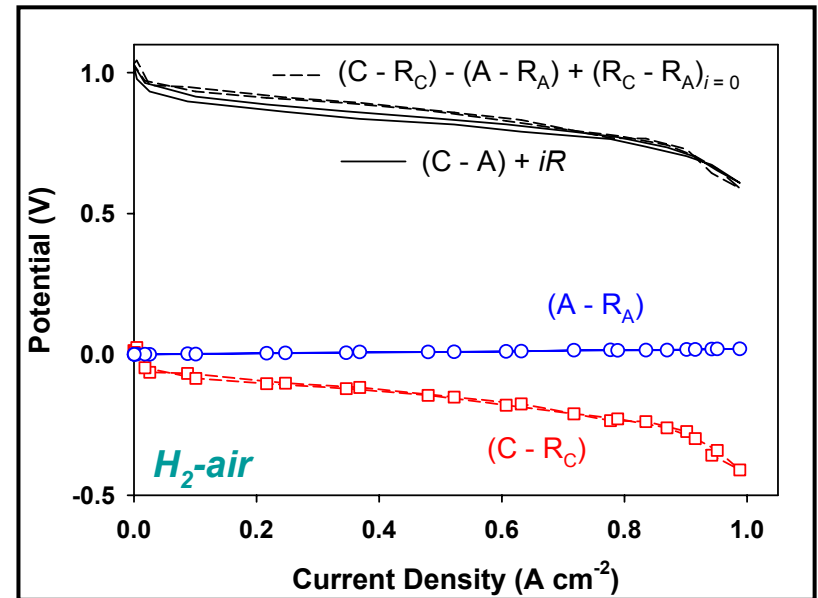

CFD Modeling

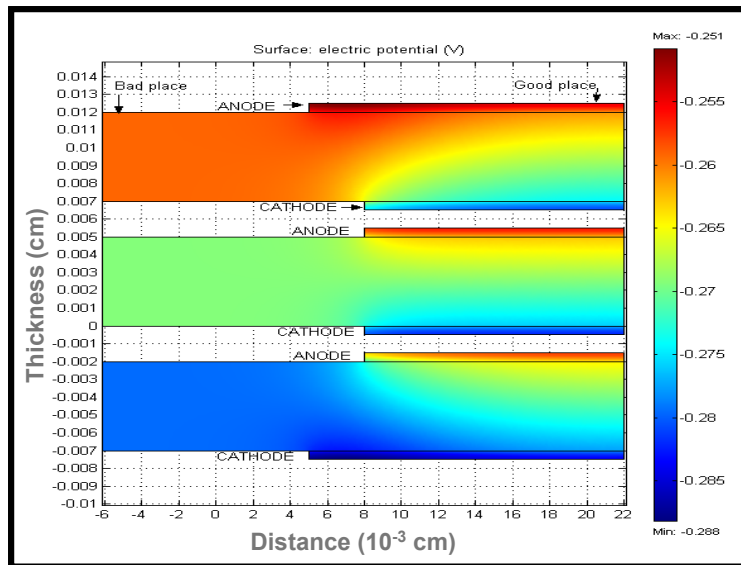

CFD modeling using FEMLAB validates the experimental results obtained for the reference electrodes: *Effects of potential distribution (top and bottom) and reactant distribution (bottom) serve to explain the performance of reference electrodes based on how and where they are implemented.*

For all cases:

Reference Electrode C. “Electrolytic Key” gave consistent and reliable results – independent of operation (representing a successful reference electrode design and implementation – a significant achievement in the study of electrode stability and durability).

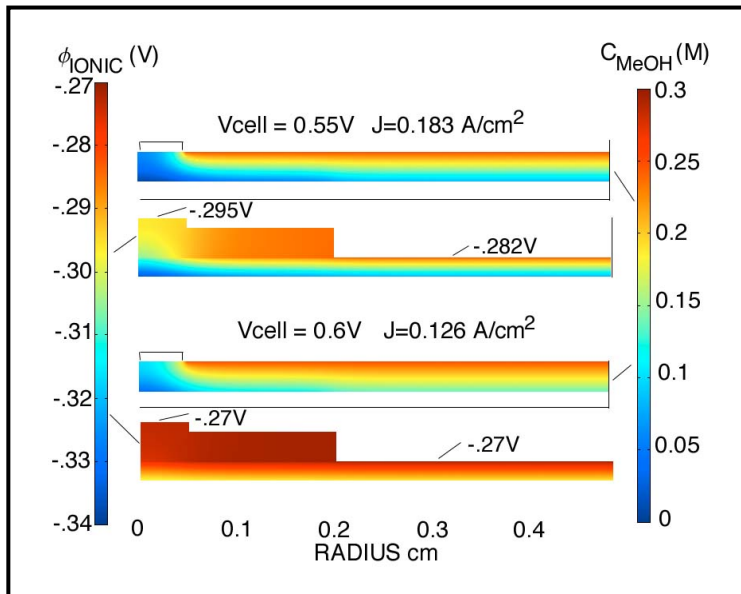

Membrane-Electrode Interface (Thrust 2)

(Springer, Kim, Pivovar)

- New (alternative) membranes offer promise in the areas of lower cost, increased performance and improved durability.
- We have determined that the membrane-electrode interface is a source of significant performance degradation in alternative membrane fuel cells, but we have also witnessed performance losses associated with the membrane-electrode interface in traditional fuel cells and cells exposed to freeze-thaw cycling.*
- We have quantified interfacial resistances and correlated them with performance losses over time (durability).
- We have experimentally isolated electrode delamination as most likely cause of performance loss.
- Model verification will let us better understand the impact and time frame of interfacial resistance and develop strategies to mitigate these performance losses.

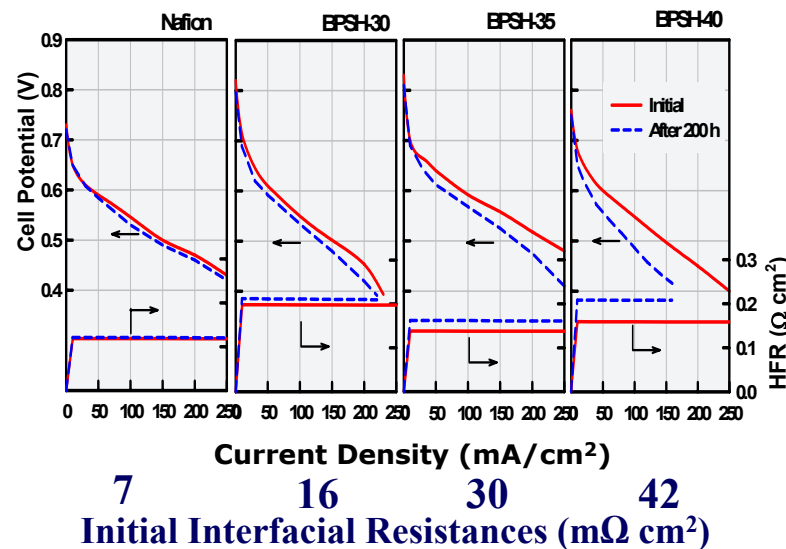
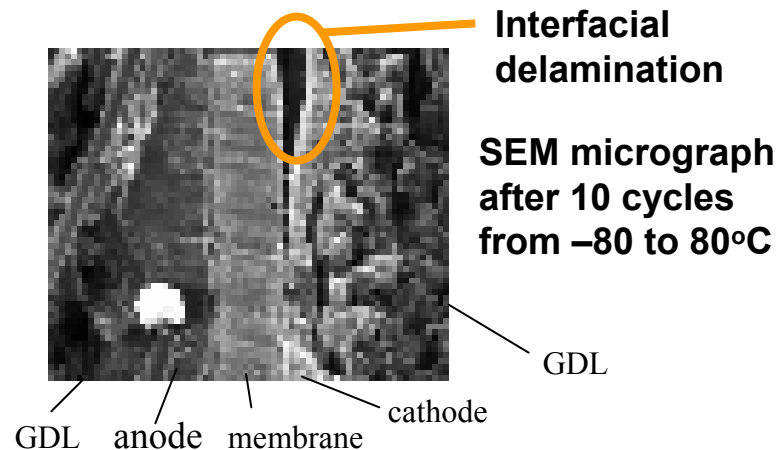

* FC41 and FCP4 2005 OHFCIT Program Review

Delamination Model

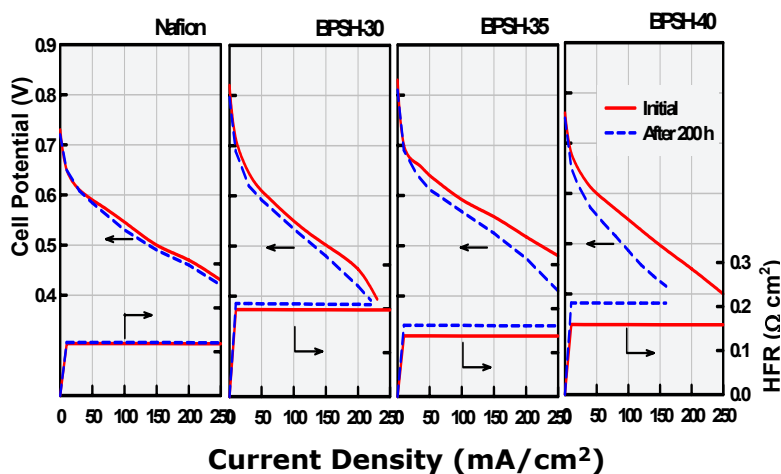

Experimental results show increasing high frequency resistance and decreasing performance with time, these results have been attributed largely to membrane-electrode delamination.

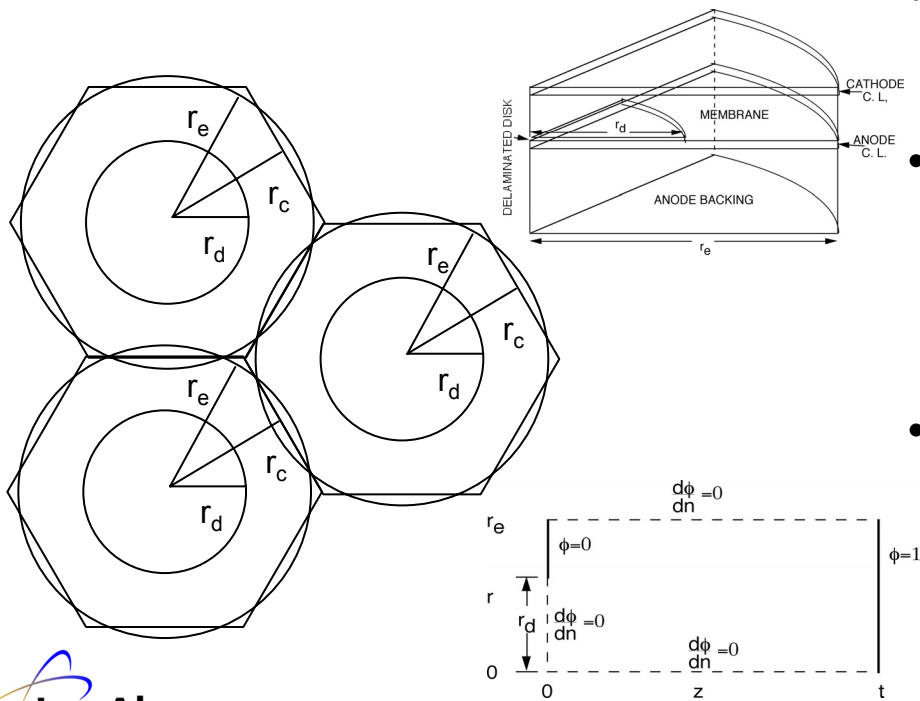

- Model delamination using cylindrical coordinates, based on hexagonal geometry covering the surface.
- Two independent variables for calculations, the size of the delaminated area (r_d) and the distance between representative hexagons (estimated as r_e).
- Include catalyst layer and membrane, and use FEMLAB to calculate changes in observed resistance and changes in fuel cell performance due to delaminations.

Effect of Delamination Size

- Streamlines for two samples with the same fraction of area occluded are shown (at right). The effect due to the size of the delamination with respect to membrane thickness can be seen by comparing the two results.
- Samples with large delaminations compared to the thickness of the membrane (top) have significantly altered streamlines compared to samples with no delamination.
- Samples with small delaminations compared to the thickness of the membrane (bottom) are relatively unchanged compared to samples without delamination and show only minor changes in resistance and losses in performance.
- Very different results in spite of having the same fraction of area delaminated.

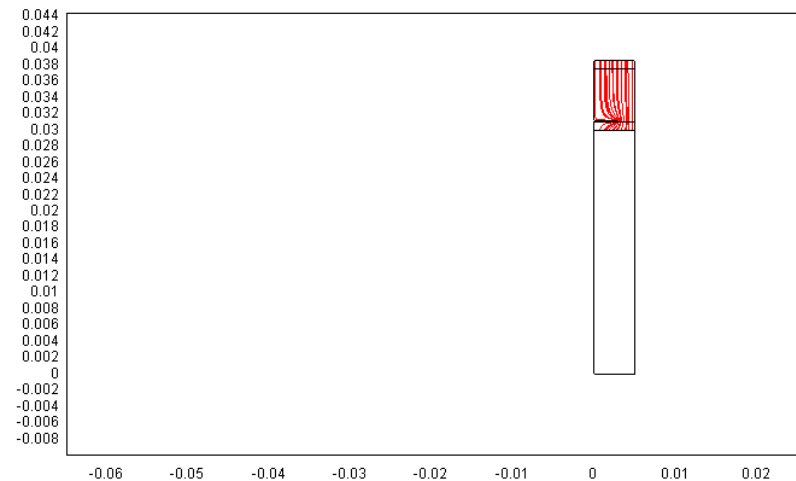
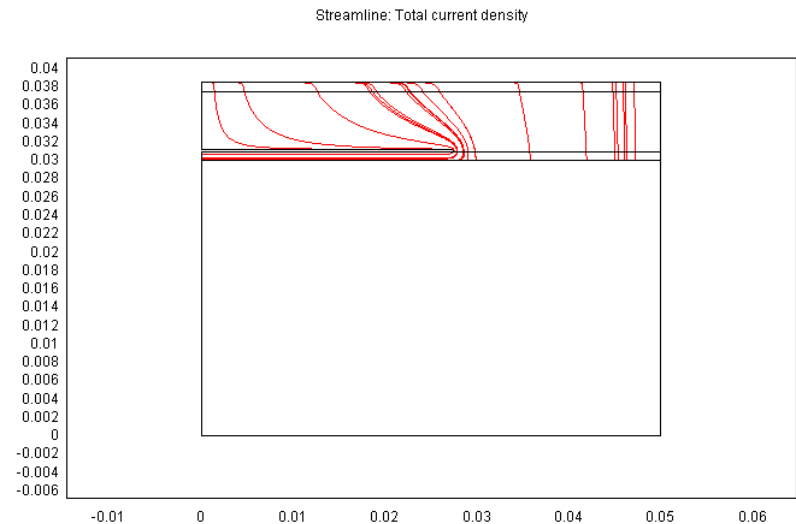

Effect of Length Scales

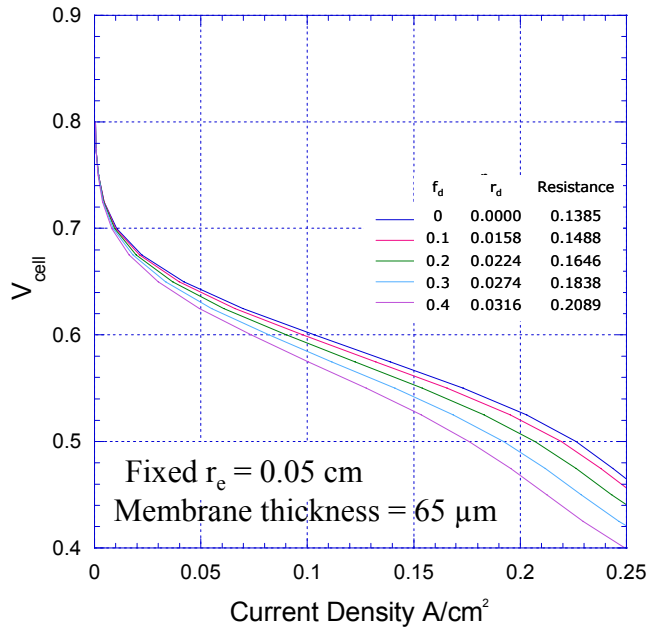

Modeling (DMFC) results with fixed repetition segment size ($r_e = 0.05$ cm) show clear tendencies for increased resistance and decreased performance with increasing delamination size (r_d). Current is forced to move laterally through the catalyst layer resistance around the delamination. This effect would result if a few delaminations grew larger over time.

Modeling (DMFC) results with fixed area delaminated ($f_d = 0.3$ or 30% of surface delaminated) shows that the ratio of membrane thickness to delamination size (r_d) is also an important variable. As delamination size gets larger, change in resistance and performance losses also grow.

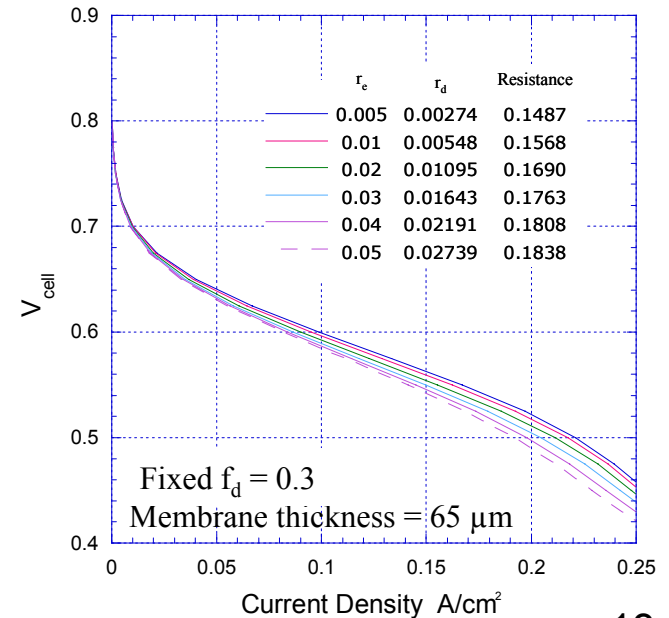

Summary/Future Interfacial Work

- We have developed a delamination model which accounts for losses in performance and increases in resistance.
- The size of the delamination and the fraction of the surface covered by delaminations were found to be the two variables affecting performance and resistance.
- The model can qualitatively match data obtained for alternative ionomer systems.
- Model will be applied to experimental systems to try and explain the size of delaminations, the fraction of the surface delaminated, and the change in delamination with operation.
- Delaminations will be investigated using microscopy, spectroscopy or other experimental techniques.
- The role of membrane and electrode properties on delamination will be further probed.

Water Influence on Oxygen Reduction (Thrust 3)

(Chlistunoff, Uribe, Pivovar)

- Our and other researchers recent and historic evidence suggest ORR might be influenced by water availability and/or activity.
- This has significant implications when it comes to low humidity operation of fuel cells and the development of higher conductivity low RH membranes.

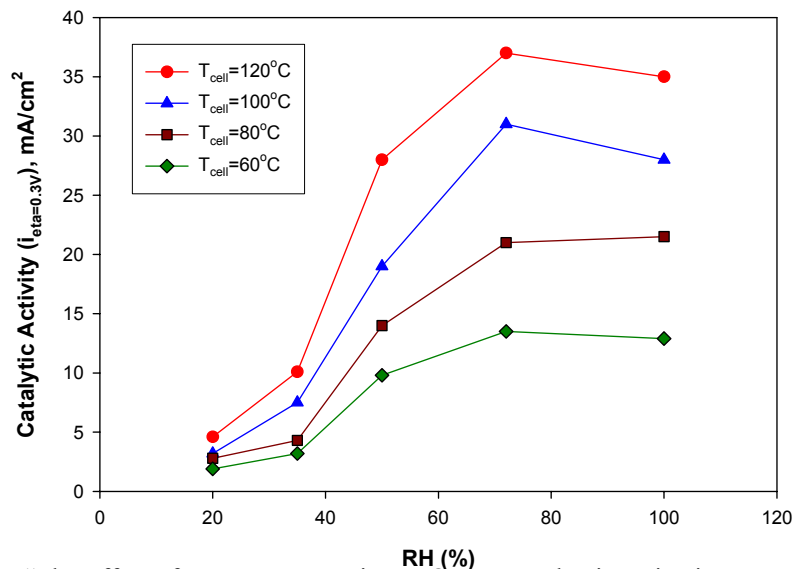

“The Effect of Ionomer Properties on Oxygen Reduction Kinetics on Platinum,” J. Fenton, H. Xu, H. Kunz, Advances in Materials for Proton Exchange Membrane Fuel Cell Systems, Pacific Grove, CA, Feb 21, 2005.

- Work by Yeager and coworkers and Ross and coworkers in the mid 80s-90s exploring the role of acid type and concentration on oxygen reduction found significant differences in kinetics that were attributed to anion adsorption effects (although the role of water activity on oxygen reduction was not dismissed).

H. Saffarian et al., J. Electrochem. Soc, 139 (1992) 2391.
M. Enayetullah et al., J. Appl Electrochem, 18 (1988) 763.

Use of Microelectrodes to Study Effects of Humidification on Oxygen Reduction

During our earlier study we demonstrated a difference in oxygen reduction between liquid and saturated vapor water (F.A.Uribe et al, J. Electrochem. Soc, 139 (1992) 765).

Here we extend this work to include humidity levels lower than 100%

Modifications of the experimental setup and conditions:

- Oxygen delivered to the minicell through two bubblers containing inert salt solutions or water and through the layer of the respective solution on the bottom of the minicell chamber
- Conventional hydrogen electrode utilizing “forming” gas (6% H₂, 94% Ar) and 0.5 M H₂SO₄ used as a reference
- Long equilibration times of the film with the gas phase water as opposed to direct film hydration (liquid water) followed by short equilibration times in the previous study
- Voltammograms recorded until a steady state electrochemical behavior was attained

Electrochemical minicell used in the previous study (minor alterations for current study)

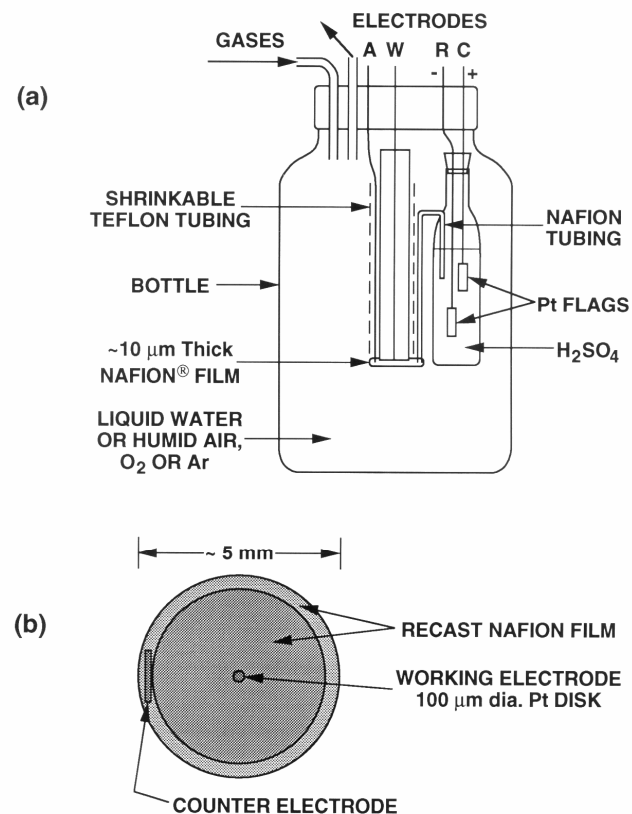

F.A.Uribe et al, J.Electrochem.Soc. 139(1992)765.

The Effect of Temperature on Oxygen Reduction

Previous study

100% RH, direct film hydration

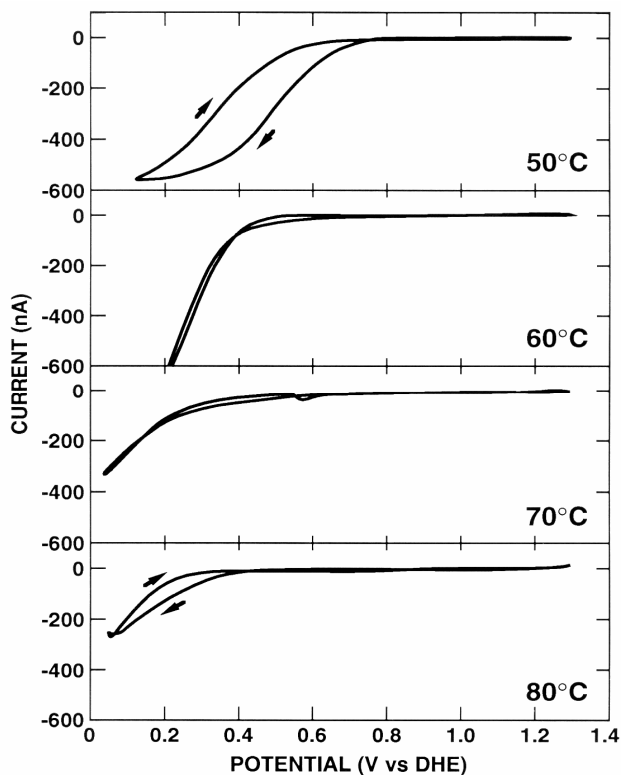

Current study

35% RH, long equilibration time

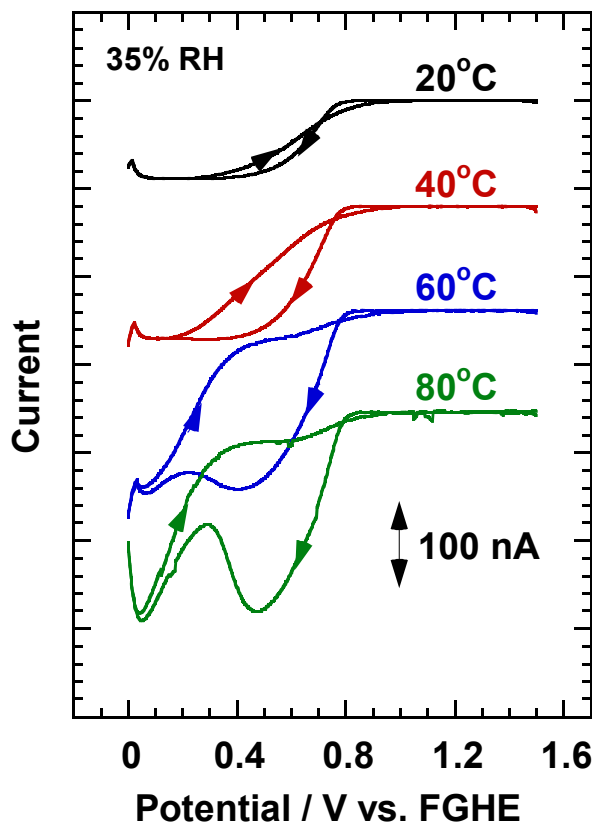

Complex mechanism of oxygen reduction

- Temperature increase leads to remarkable changes in voltammetry

- Stronger temperature effect on the limiting current of oxygen reduction than that expected for thermally activated diffusion

F.A.Urbe et al, J.Electrochem.Soc. 139(1992)765.

The Effect of Relative Humidity on Oxygen Reduction

Previous study

100% RH, direct film hydration

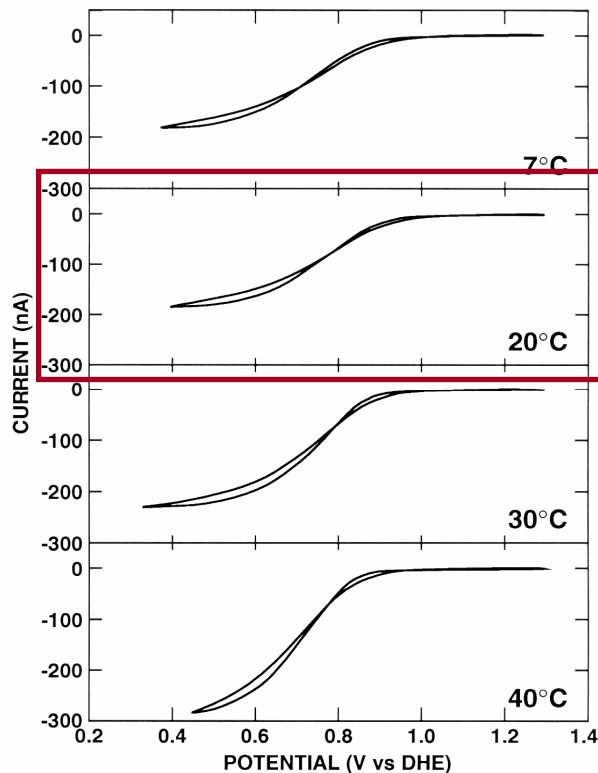

Current study

20°C, long equilibration time

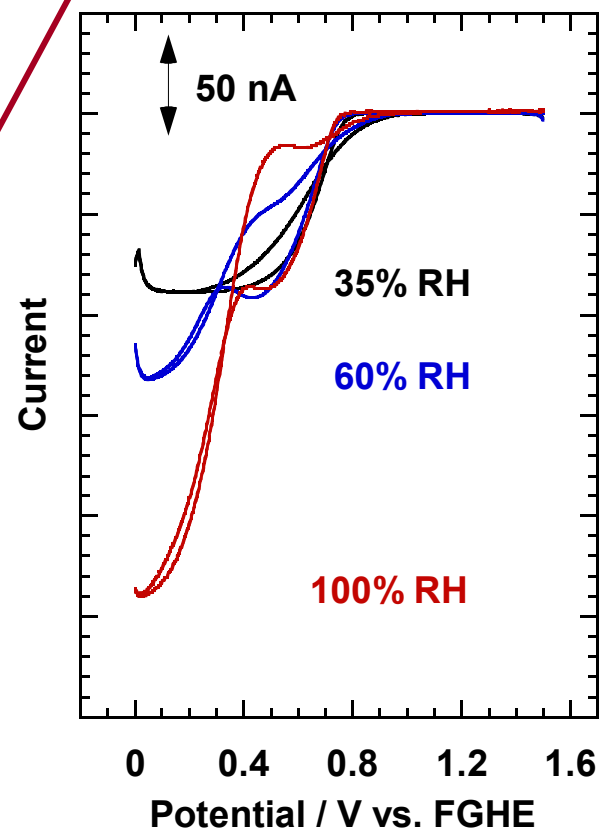

Complex mechanism of oxygen reduction

- Significantly different voltammetry at different relative humidity
- Oxygen reduction on platinum can occur at a high rate even when the Nafion film is strongly dehydrated
- Two mechanisms of ORR may be operating depending on the local Nafion hydration at its interface with platinum
- Stronger Nafion hydration seems to increase the contribution from the mechanism occurring at higher overvoltages

F.A.Uribe et al, J.Electrochem.Soc. 139(1992)765.

Future Oxygen Reduction Work

1. Continuation of work on the effects of relative humidity on oxygen reduction
2. Synthesis and testing of alternative catalyst supports
3. Synthesis and testing of alternative catalysts, e.g., alloys of non-precious metals
4. Theoretical and experimental studies of model systems that could help reduce corrosion of the catalyst/support, e.g., less acidic non-Nafion membranes

Electrochemical studies will involve rotating ring disk (RRDE) and interdigitated array electrode voltammetry. Both techniques are particularly useful in elucidating reaction mechanisms and detecting reaction intermediates (particularly hydrogen peroxide which is of interest for performance degradation). Interdigitated electrodes will be used in further studies of the effects of relative humidity on oxygen reduction.

Interdigitated array electrode

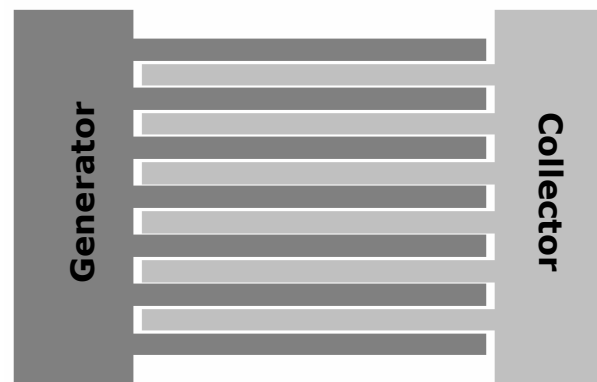

- Two sets of “comb” type working electrodes with micron size fingers and micron size gaps between them
- The collector electrode used to detect products or intermediates produced by the generator electrode

Higher pH Electrolytes (Thrust 4)

(Gilbertson, Boncella, Janicke, Asthigiri, Pratt, Kim, Pivovarov)

- A primary shortcoming in current PEM fuel cells is the inability for anything other than platinum to give necessary lifetimes and performances in the strongly acidic conditions of the fuel cell, and even then the amount platinum needed is excessive.
- Higher pH is known to improve oxygen reduction kinetics and improve material stability. If higher pH electrolytes with good conductivity were developed, other materials such as Ni (a good catalyst in alkaline fuel cells) might be enabled.

$T = 298.15\text{K}$, $m = 1 \times 10^{-6}$
<http://www.crct.polymtl.ca/ephweb.php>

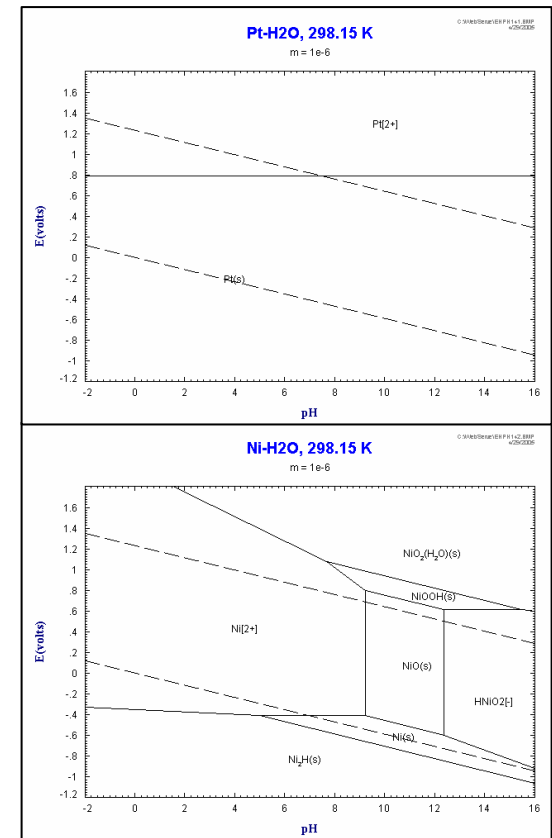

• Our approach is to combine experiment and theoretical studies to examine the possible application of imidazole “buffered” solutions capable of high proton conductivity. Thereby addressing key issues of cost, durability and perhaps performance of fuel cells systems.

Imidazole-based Conduction

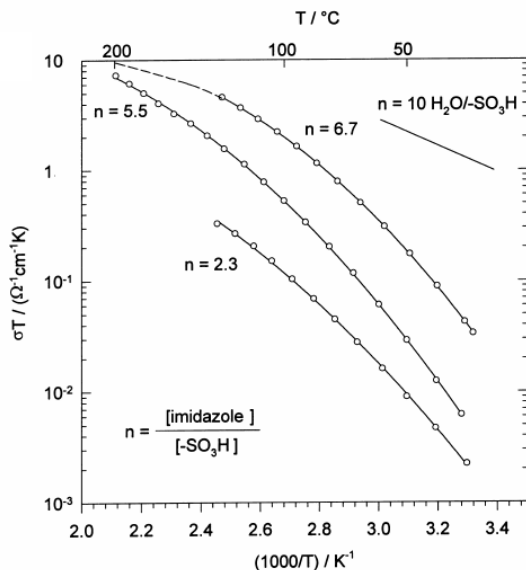

(Kreuer et. al, Electrochimica Acta, 43, 1998, 1281)

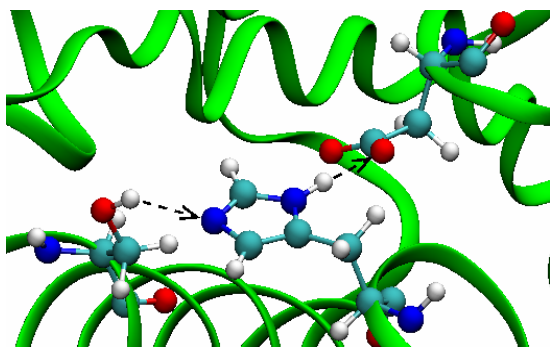

- Imidazole systems have demonstrated significant proton conductivity (top left).
- Because imidazole based conduction does not require high concentrations of ‘free’ protons, it may be possible to have high rates of proton transport under conditions that are not strongly acidic.
- Less aggressive chemical environments may result in improved kinetics, but more importantly may increase materials choices for catalysis.
- In investigating imidazole conduction we will also explore biological systems (bottom left) where imidazole is known to act as a proton shuttle.

pKa's of Substituted Imidazoles

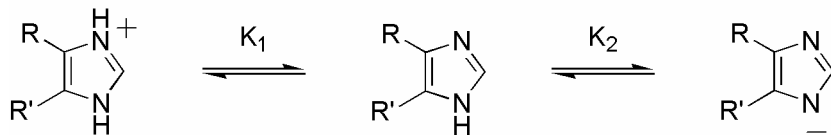

R	R'	pK _{a1}	pK _{a2}
CH ₃	H	7.45	>15**
H	H	6.95	15
Br	H	3.7	11*
Cl	H	2.9*	11*
NO ₂	H	1.5	9.1
Cl	Cl	<1**	8*
CN	CN	<1**	6*

* Values are calculated using Advanced Chemistry Development (ACD/Labs) Software Solaris V4.67 (© 1994-2005 ACD/Labs)
 ** Estimated values.

Ab-initio pK_{a1} calculations

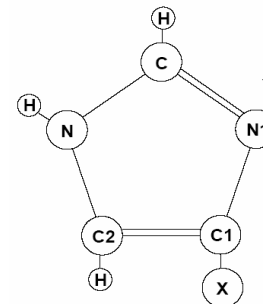

Mono-substituted				Di-substituted			
X	ΔG_{gas}	$\Delta\mu$	ΔpK_a	X	ΔG_{gas}	$\Delta\mu$	ΔpK_a
H	0.0	0.0	0.0	H	0.0	0.0	0.0
-OCH ₃	-2.2	-4.3	-4.8	-OCH ₃	1.8	-7.5	-4.2
-F	-11.2	0.8	-7.6	-F	-17.8	1.7	-11.8
-CN	-15.6	1.4	-10.4	-CN	-28.0	2.5	-19.0
-NO ₂	-18.6	0.7	-13.2	-NO ₂	-33.1	4.0	-21.4

Depending on chemical substitution and contacting solution (strong acid or base), imidazoles can be used as buffers to span pH ranges from very acidic to very basic.

Model calculations show expected trends with substitution, however magnitude of ΔpK_a is larger than expected. pKa values are notoriously difficult to predict using quantum mechanics.

Proton Transport in Imidazoles

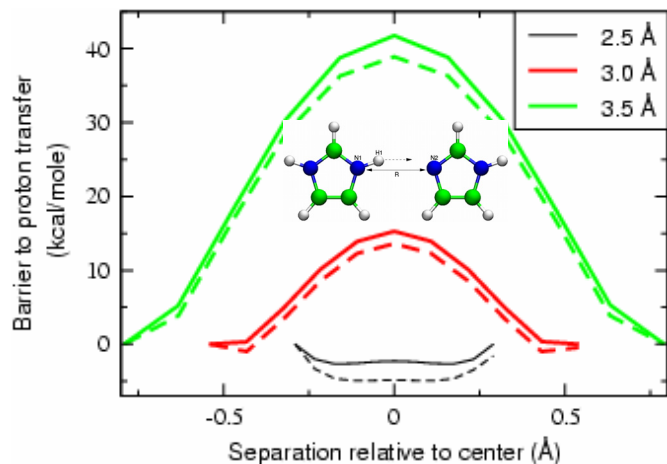

Energy barriers to proton transport (by hopping) were explored as a function of separation distance (solid lines) and compared to energy barriers in water (dashed lines) using *ab initio* calculations. Imidazole showed energy barriers very similar to water for these very ordered systems.

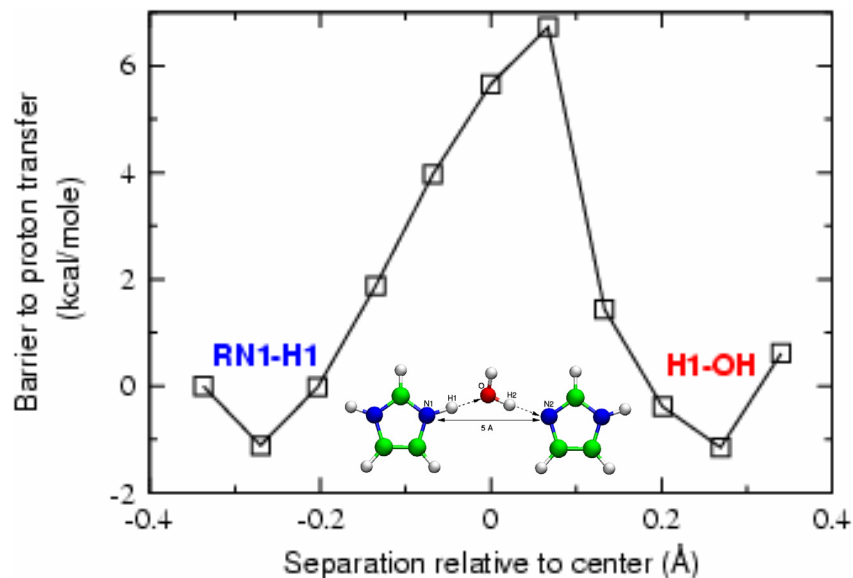

Inserting a water molecule between the imidazoles allowed proton transport to occur at longer length scales with an activation energy similar to that of proton transport in bulk water (3-6 kcal/mol).

Studies of an excess proton in an imidazole containing solution have also been undertaken.

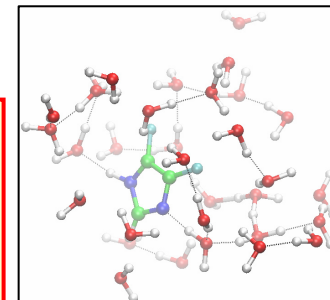

Conductivity of Imidazole Containing Solutions

^{19}F PFGSE Results (inset ^{19}F and ^1H data)

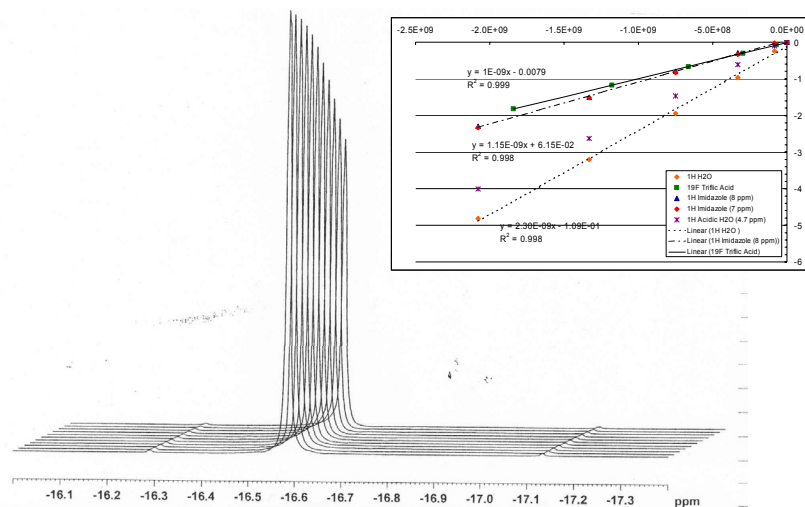

Sample	pH	Conductivity (mS/cm)
2 M imidazole 1 M $\text{CF}_3\text{SO}_3\text{H}$ in D_2O [estimated from NMR]	8	58 (at 22°C) 65 (at 30°C) [80 (at 30°C)]
2 M imidazole 1 M $\text{CF}_3\text{SO}_3\text{H}$ in H_2O	8	68 (at 22°C) 79 (at 30°C)

$$D_{\text{Triflic Acid from F-19}} = 1.00 \times 10^{-5} \text{ cm}^2/\text{s}$$

$$D_{\text{Imidazole from H-1}} = 1.15 \times 10^{-5} \text{ cm}^2/\text{s}$$

We have prepared and characterized 'buffered' solutions of triflic acid and excess imidazole. The high pH of the solution suggests 'free' protons play little role in the observed conductivity, while differences in conduction between D_2O and H_2O suggest proton hopping may be important. However, conductivity values estimated from pulsed field gradient NMR based only on vehicle mechanism conduction are higher than those found by conductivity measurements and more work needs to be done to understand these phenomenon.

Work investigating higher pH electrolytes is very preliminary. Areas of future investigation include: effects of D_2O versus H_2O , higher concentration imidazole solutions, strongly basic buffered solutions, and substituted imidazoles.

Publications and Presentations

- ***Presentation***

1. “Direct Measurement of iR -free Individual-Electrode Overpotentials in PEFC,” Piotr Piela, Tom Springer, Mahlon Wilson, John Davey and Piotr Zelenay, 206th Meeting of The Electrochemical Society Honolulu, Hawaii, October 3-8, 2004.

- ***Publication***

1. “Direct Measurement of iR -Free Individual-Electrode Overpotentials in PEFC,” P. Piela, T.E. Springer, M.S. Wilson, J. Davey and P. Zelenay, in *Proton Conducting Membrane Fuel Cells IV*, M. Murthy, (Ed.), Proceedings of the 206th Meeting of the Electrochemical Society, Honolulu, Hawaii, October 3 – 8, 2004; Electrochemical Society, Pennington, New Jersey, submitted.

Fundamental Science for Performance, Cost and Durability

2005 DOE Hydrogen Program Review

Bryan Pivovar

Los Alamos National Lab

Tuesday May 24, 2005

Project #:

FCP28

This presentation does not contain any proprietary or confidential information

Hydrogen Safety

The most significant hydrogen hazard associated with this project is:

Hydrogen leak in the hydrogen supply leading to accumulation in the room with ignition leading to an explosive event.

Hydrogen Safety

Our approach to deal with this hazard is:

In labs with hydrogen supply from cylinder banks or from a hydrogen generator, hydrogen sensors have been installed and are interlocked with the hydrogen gas supply.

Two sensors are installed in every room for redundancy.

Sensors installed at ceiling level where accumulation is most severe.

H₂ sets off the alarm at 10% of Lower Flammability Limit (LFL).

In rooms that use only bottled hydrogen, only a single cylinder is in the room at any given time and bottle sizes are limited to ensure being safely below the LFL of the room even with complete release of a full cylinder.

Work has been reviewed and approved through Los Alamos National Lab's safety programs:

Hazard Control Plan (HCP) - Hazard based safety review

Integrated Work Document (IWD) - Task based safety review

Integrated Safety Management (ISM)