

Battery Thermal Management in EVs and HEVs: Issues and Solutions

Ahmad A. Pesaran
National Renewable Energy Laboratory
1617 Cole Blvd.
Golden, Colorado 80401

Advanced Automotive Battery Conference
Las Vegas, Nevada
February 6-8, 2001

ABSTRACT

Thermal management of batteries in electric vehicles (EVs) and hybrid electric vehicles (HEVs) is essential for effective operation in all climates. This has been recognized in the design of battery modules and packs for pre-production prototype or production EVs and HEVs. Designs are evolving and various issues are being addressed. There are trade-offs between performance, functionality, volume, mass, cost, maintenance, and safety. In this paper, we will review some of the issues and associated solutions for battery thermal management and what information is needed for proper design of battery management systems. We will discuss such topics as active cooling versus passive cooling, liquid cooling versus air cooling, cooling and heating versus cooling only systems, and relative needs of thermal management for VRLA, NiMH, and Li-Ion batteries.

INTRODUCTION

Battery performance, life, and cost directly affect the performance, life, and cost of the electric vehicles (EVs) and hybrid electric vehicles (HEVs). Battery temperature influences the availability of discharge power (for start up and acceleration), energy, and charge acceptance during energy recovery from regenerative braking. These affect vehicle drive-ability and fuel economy. Temperature also affects the life of the battery. Therefore, ideally, batteries should operate within a temperature range that is optimum for performance and life. The desired operating temperature range is different for different battery types (with different electrochemistry). Usually, the optimum temperature range for the battery operation (desired by the battery manufacturer) is much narrower than the specified operating range for the vehicle (identified by the vehicle manufacturer). For example, the desired operating temperature for a lead acid battery is 25°C to 45°C, however the specified vehicle operating range could be -30°C to 60°C.

In addition to considering the (absolute) temperature of a battery pack, uneven temperature distribution in a pack should be also considered. Temperature variation from module to module in a pack could lead to different charge/discharge behavior for each module. This, in turn, could lead to electrically unbalanced modules/packs, and reduced pack performance [1]. For high temperature batteries such as ZEBRA and lithium metal polymer batteries, thermal management is considered an integral part of the battery pack and has been included in the design by the battery manufacturers. The need for battery thermal management for ambient temperature batteries such as valve regulated lead acid (VRLA), nickel metal hydride (NiMH), and lithium

ion (Li-Ion) was not obvious initially, however, EV and HEV battery and vehicle manufacturers have come to realize such a need. Current prototype or production EVs and HEVs with ambient temperature batteries have battery thermal management systems - some more elaborate than others.

Over the last several years, with support from US Department of Energy, NREL has been working with U.S. automobile manufacturers and their battery pack suppliers (as part of the Partnership for a New Generation of Vehicles (PNGV) program) to identify and resolve thermal issues associated with battery packs for HEVs [2]. To evaluate battery pack designs and provide solutions for battery thermal issues, we have used heat transfer and fluid flow principles, finite element thermal analysis, and heat transfer and fluid flow experiments [1, 3, and 5]. We have used thermal imaging techniques and battery calorimetry to measure thermal characteristics of modules and cells in support of battery pack thermal evaluation and design [1, 5, 6, and 7]. Further information on our battery thermal management activities and publications can be found on the Web site <http://www.ctts.nrel.gov/BTM>.

In this paper, we will look at various requirements for a battery thermal management system (BTMS) for “ambient temperature” batteries and take a look at trade offs between performance, functionality, volume, mass, cost, maintenance, and safety. We will review some of the issues and associated solutions for battery thermal management and the information that is needed for proper design of battery management systems. We will discuss topics such as active cooling versus passive cooling; liquid cooling versus air cooling; cooling and heating versus cooling only systems; and the relative need of thermal management for VRLA, NiMH, and Li-Ion batteries.

DESIRED ATTRIBUTES OF A THERMAL MANAGEMENT SYSTEM

The goal of a thermal management system is to deliver a battery pack at an optimum average temperature (dictated by life and performance trade-off) with even temperature distribution (or only small variations between the modules and within the pack) as identified by the battery manufacturer. However, the pack thermal management system has to meet the requirements of the vehicle as specified by the vehicle manufacturer—it must be compact, lightweight, low cost, easily packaged, and compatible with location in the vehicle. In addition, it must be reliable, and easily accessible for maintenance. It must also use low parasitic power, allow the pack to operate under a wide range of climate conditions (very cold to very hot), and provide ventilation if the battery generates potentially hazardous gases. A thermal management system may use air for heat/cooling/ventilation (Figure 1), liquid for cooling/heating (Figure 2), insulation, thermal storage such as phase change materials, or a combination of these methods. The thermal management system may be passive (i.e., only the ambient environment is used) or active (i.e., a built-in source provides heating and/or cooling at cold or hot temperatures). The thermal management control strategy is done through the battery electronic control unit.

DESIGNING BATTERY THERMAL MANAGEMENT SYSTEMS

As with any system, there are several approaches to designing a BTMS. The approach depends on the desired level of sophistication, availability of information, and timetable/budget for a particular project. Based on our learning experience, we have proposed a systematic approach to designing and evaluating a BTMS [3]. A summary of the steps is provided here.

1. *Define the BTMS design objective and constraints.* These are dictated by the battery type, acceptable temperature range, acceptable temperature variation, and the packaging requirements for the vehicle.

2. *Obtain module/pack heat generation and heat capacity.* These will affect the size of the cooling/heating system and how fast the pack responds to temperature fluctuations.
3. *Perform a first-order module and BTMS evaluation.* Preliminary analysis is performed to determine the transient and steady-state thermal response of the module and pack in order to select an initial strategy. Various options, choices of heat transfer medium (air or liquid), and different flow paths (direct or indirect, series or parallel) are evaluated. We believe that to design having a good BTMS starts with a designing a module with thermal behavior in mind.
4. *Predict the battery module and pack thermal behavior.* Detailed analysis is done to evaluate the impact of various parameters under various conditions and driving duty cycles for both battery module and pack.
5. *Design a preliminary BTMS.* Based on the packaging and expected performance, the system parameters are specified.
6. *Build and test the BTMS.* A prototype BTMS is built and then tested on the bench and in the vehicle under various loads and conditions.
7. *Improve the BTMS.* Based on the test data and analysis, the design is fine tuned or modified for the next step.

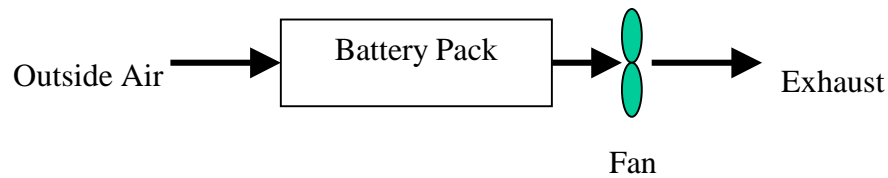

A. *Passive Cooling – Outside Air Ventilation*

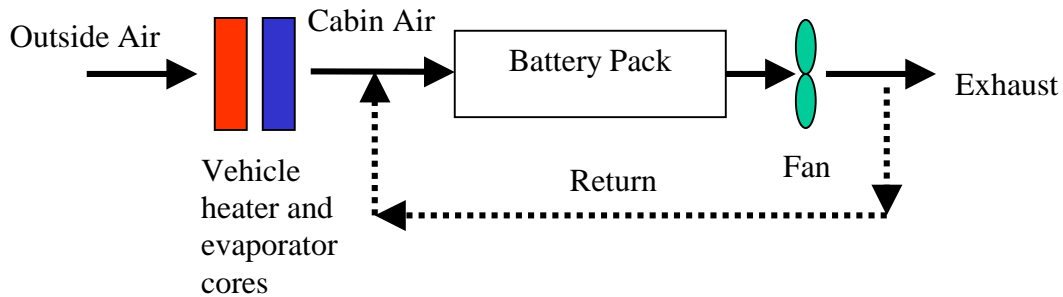

B. *Passive Heating and Cooling – Cabin Air Ventilation*

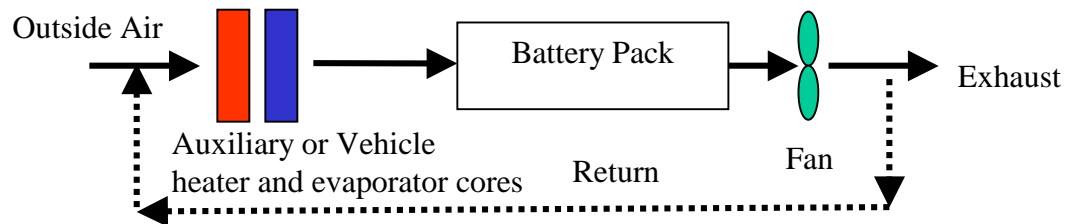

C. *Active Heating and Cooling – Outside or Cabin Air*

Figure 1. General Schematic of Thermal Management using Air

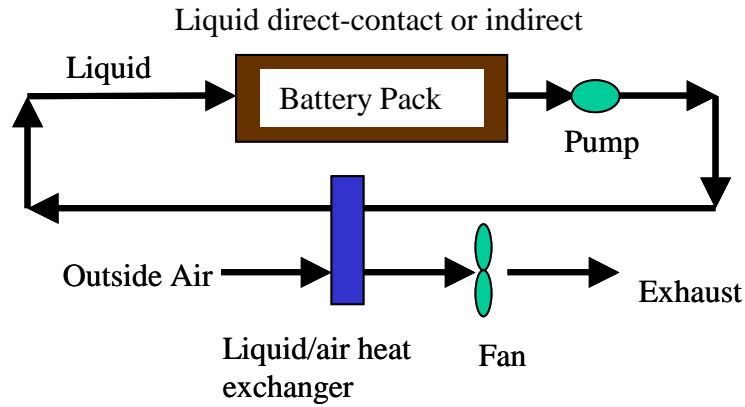

D. Passive Cooling – Liquid Circulation

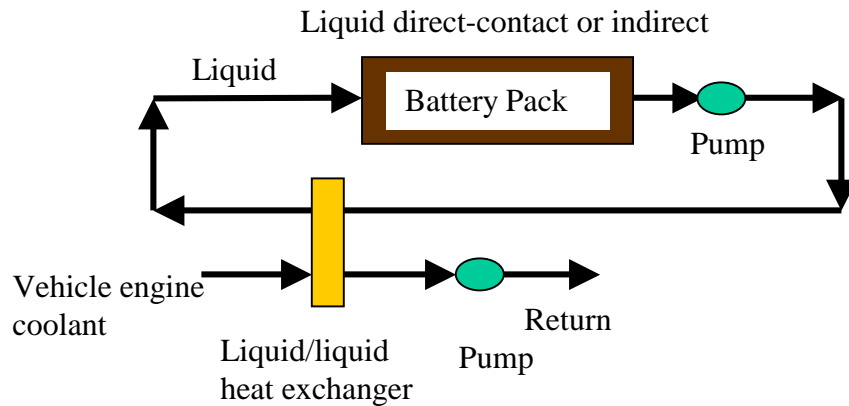

E. Active Moderate Cooling/Heating – Liquid Circulation

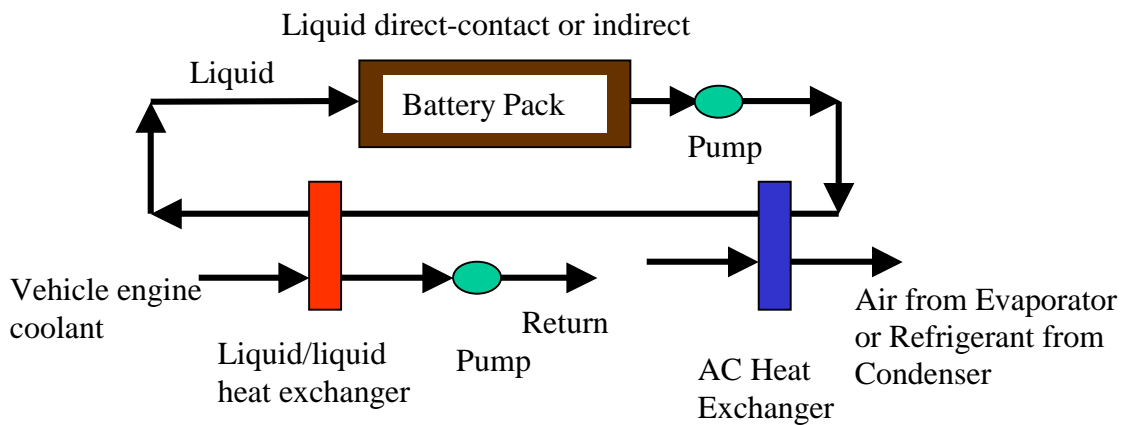

F. Active Cooling and Heating – Liquid Circulation

Figure 2. General Schematic of Thermal Management using Liquid

DISCUSSION

In the following sections, we discuss a selected number of battery thermal management issues of interest to the community and organizers of the conference.

Heat Generation and Heat Capacity

The magnitude of the overall heat generation rate from a battery pack under load dictates the size and design of the cooling system. The heat generation (due to electrochemical enthalpy change and electrical resistive heating) depends on the chemistry type, construction, temperature, state of charge, and charge/discharge profile. At NREL, we have been using a large custom-built calorimeter to measure the heat generation from cells/modules with various cycles, state of charge, and temperature [3, 7, and 8]. Table 1 shows some typical results for various batteries. These and other data show that that, for the same current draw, a NiMH battery generates more heat than a VRLA or Li-Ion batteries at elevated temperatures (> 40°C). Heat generation from VRLA and Li-Ion is roughly the same for similar currents. At room temperature, less heat is generated for NiMH for the same current, but NiMH is not as energy efficient. Generally, as temperature decreases more heat is generated because of an increase in resistance in the cells. As the discharge rate increases, more heat is generated. Under certain conditions, the battery electrochemical reaction could be endothermic, as shown in Table 1 for Li-Ion battery at C/1 discharge rate at 50°C.

Table 1. Heat generation from Typical HEV/EV Modules using NREL's Calorimeter [7and 8]

Battery Type	Cycle	Heat Generation (W)/Cell		
		0°C	22-25°C	40-50°C
VRLA, 16.5 Ah	C/1 Discharge, 100% to 0% State of Charge	1.21	1.28	0.4
VRLA, 16.5 Ah	5C Discharge, 100% to 0% State of Charge	16.07	14.02	11.17
NiMH, 20 Ah	C/1 Discharge, 70% to 35% State of Charge	-	1.19	1.11
NiMH, 20 Ah	5C Discharge, 70% to 35% State of Charge	-	22.79	25.27
Li-Ion, 6 Ah	C/1 Discharge, 80% to 50% State of Charge	0.6	0.04	-0.18
Li-Ion, 6 Ah	5C Discharge, 80% to 50% State of Charge	12.07	3.50	1.22

In order to do any reasonable transient thermal analysis, the designer needs to know the heat capacity of a module in order to determine the thermal mass of the pack. Overall or average heat capacity can either be measured in a calorimeter [7 and 8] or calculated from knowledge of the heat capacity of individual components using a mass-weighted average of cell/module components. Typical heat capacity for a VRLA (16.5 Ah) is 660 J/kg/K, for a NiMH (20 Ah) heat capacity is 677.4 J/kg/K, and for Li-Ion (6 Ah) heat capacity is 795 J/kg/K. Figure 3 shows the impact of heat generation and heat capacity on the temperature rise of a selected EV module using air-cooling.

Module Temperature Distribution

The design of a battery cell/module dictates its temperature distribution. The heat generation in a module may not be spatially uniform due to several factors: aspect ratio, number of cells and

geometry, thermal conductivity of the case, placement of the positive and negative terminals, size and position of the cell interconnects within the module, and spatial variation of current density within a cell. Non-uniform heat generation could lead to non-uniform temperature distribution in the module.

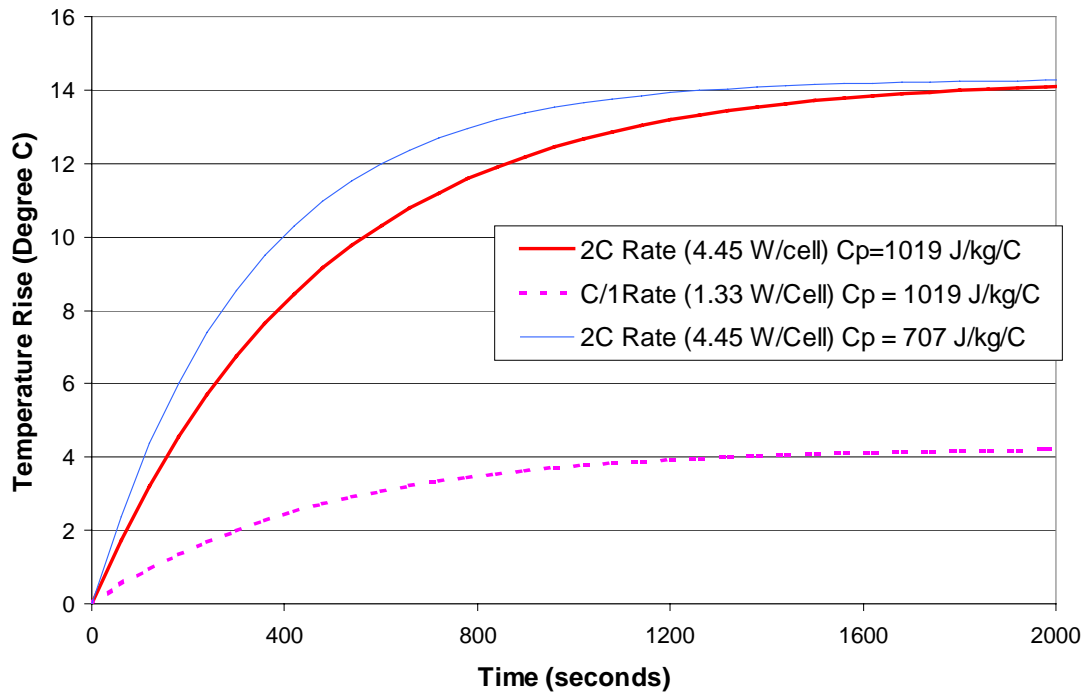

Figure 3. Transient Temperature Rise in a Module with Constant Heat Generation

As an example, thermal images of a 6-cell Optima lead acid HEV battery with terminals on the same side indicated a modest variation in axial heat generation and a 20°C temperature distribution in the Optima lead acid HEV module [5]. On the other hand, Saft high-power lithium ion cells with a hollow core for cooling, terminal placements at both ends, and high thermal-conductivity of the active material and the case material achieved a relatively uniform temperature distribution with variation of less than 2°C [6]. Ovonics Battery Company has recently integrated liquid cooling within their high-power NiMH modules (Figure 4) by jacket cooling each cell to achieve uniform temperature distribution in a module in addition to better temperature control.



Figure 4. Water Cooled Ovonic NiMH Module
(10 cells, 12 V, 12 Ah, 48 Whr/kg, 550 W/kg)

Air Cooling versus Liquid Cooling

Choice of heat transfer medium has a significant impact on the performance and cost of the battery thermal management system. The heat transfer medium could be air, liquid, phase change material, or any combination. Heat transfer with air is achieved by directing/blowing the air across the modules (Figure 1). However, heat transfer with liquid could be achieved either through discrete tubing around each module; with a jacket around the module; submerging modules in a dielectric fluid for direct contact; or placing the modules on a liquid heated/cooled plate (heat sink). If the liquid is not in direct contact with modules, such as in tubes or jackets, the heat transfer medium could be water/glycol or even refrigerants, which are common automotive fluids. If modules are submerged in the heat transfer liquid, the liquid must be dielectric, such as silicon-based or mineral oils, to avoid any electrical shorts.

Using the air as the heat transfer medium may be the simplest approach, but it may not be as effective as heat transfer by liquid. The rate of heat transfer between the walls of the module and the heat transfer fluid depends on the thermal conductivity, viscosity, density, and velocity of the fluid. For the same flow rate, the heat-transfer rate for most practical direct-contact liquids such as oil is much higher than with air because of the thinner boundary layer and higher fluid thermal conductivity. However, because of oil's higher viscosity and associated higher pumping power, a lower flow rate is usually used, making the oil heat transfer coefficient only 1.5 to 3 times higher than with air. Indirect-contact heat transfer liquids such as water or water/glycol solutions generally have lower viscosity and higher thermal conductivity than most oils, resulting in higher heat transfer coefficients. However, because the heat must be conducted through walls of the jacket/container or fins, indirect contact effectiveness decreases.

For example, in one of our previous studies, we compared air with direct liquid (oil) cooling for VRLA modules in a pack. Based on cooling need and pressure drop considerations, we selected an air mass through flow rate of 50 g/s, which at atmospheric conditions (25 °C) has a volumetric flow rate of 43 L/s. Using the classic correlation for turbulent flows, the average heat transfer rate was 25 W/m²K. An equal mass flow rate of a mineral oil had a volumetric flow rate of only 0.057 L/s, resulting in an average heat transfer rate of 57 W/m²K (2.3 times higher than air). The same mass flow rate using water for indirect cooling could have resulted in a volumetric flow rate of 0.049 L/s and a heat transfer rate of 390 W/m²K for indirect cooling, but one must also consider heat transfer resistance of containment walls which reduces effective heat removal.

Using the finite element analysis and non-uniform heat generation, we obtained the transient and steady state thermal performance for a 12-V, 6-cell HEV VRLA module using air and liquid cooling. Figure 5 shows the maximum temperature at the top, middle, and bottom of the cell versus time for air-cooling and oil cooling, respectively. Note that the module in the oil-cooling case is cooler and reaches steady state much more quickly than the air-cooling case because of the higher heat transfer rate of liquid (higher thermal conductivity of oil). An interesting observation is that the temperature gradient in the cell core remained about the same for either air cooling or liquid cooling; this results from the dominant effect of non-uniform axial heat generation within the module. This means that the construction and design of the module play an important role on how it performs thermally. Inter-cell cooling may be required for better thermal performance. That is why Ovonic Battery Company is liquid cooling each individual cell using a serpentine design rather than jacket cooling the whole module as others have done in the past. Although liquid cooling/heating is more effective and takes up less volume, it has its drawbacks. It could have more mass, has a potential for leaks, need more components (comparing Figures 1 and 2), and could cost more. Maintenance and repair of a liquid cooled pack is more involved and costlier. Indirect liquid cooling, with either jackets or cold plate is easier to handle than direct liquid cooling.

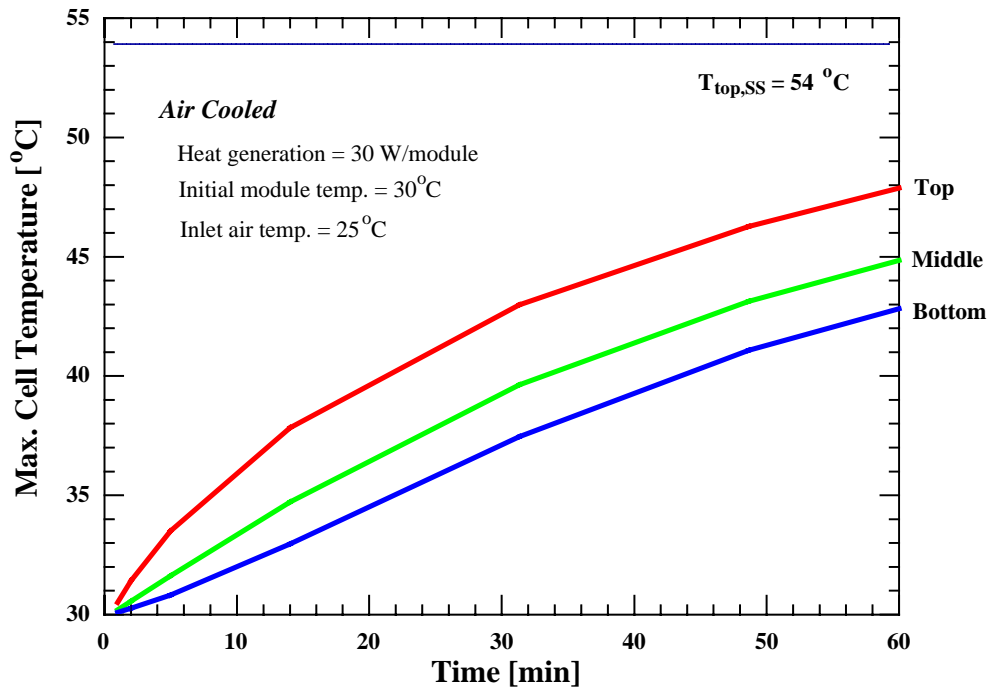
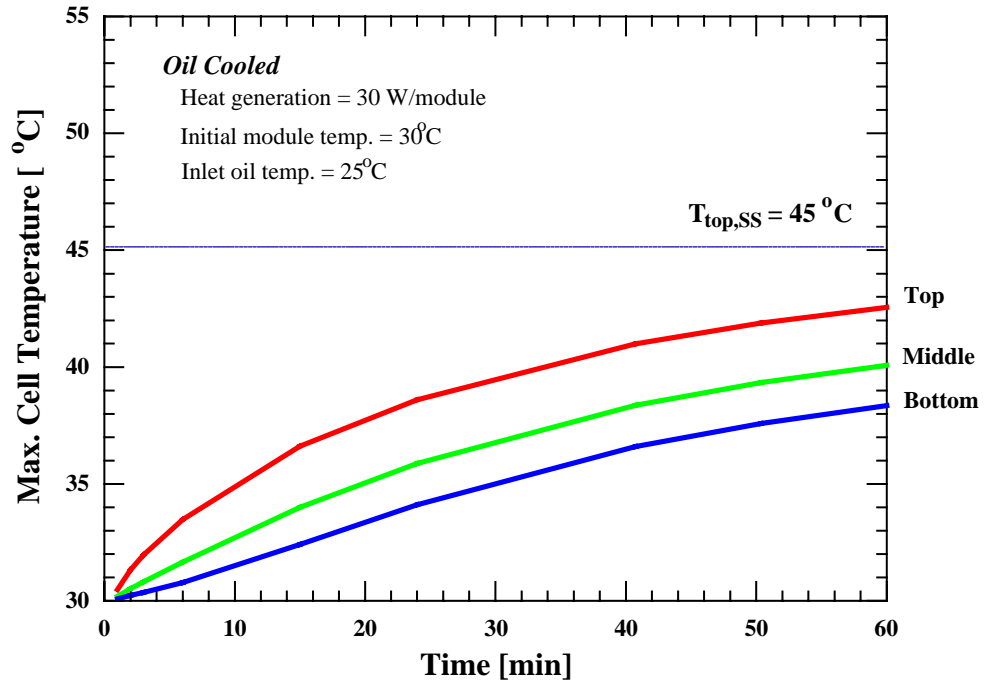

Figure 5. Transient and steady-state comparison of cooling an Optima module with liquid or air based on a similar parasitic pump/fan power (The top, middle, and bottom refer to the vertical location of the modules.)

Active versus Passive Systems

Because of cost, mass, and space considerations and their use in mild climates, battery packs in early vehicles, particularly EVs, did not use heating or cooling units and depended on blowing ambient air for rejection of heat from the batteries (Figure 1.A). Early prototype HEVs also used passive ambient air-cooling. Current production HEVs (Honda Insight and Toyota Prius) use cabin air for cooling/heating of the pack. Although the ambient air is heated and cooled by the vehicle air conditioning (AC) or heating system, it is still considered to be a passive system. Figure 2.D shows a passive liquid system that uses ambient air for heat rejection. For these passive systems, the ambient air must have a mild temperature (10°C-35°C) for the thermal management to work; otherwise the pack performance can suffer in very cold or very hot conditions. Outside of these conditions, active components such as evaporators, heating cores, engine coolant, or even electric and fuel-fired heaters are needed.

Cooling Only Systems versus Cooling and Heating Systems

EVs were initially aimed for the mild to warm climate of California. The battery performance is generally better at higher temperature; however, life can get shorter with higher temperature. So batteries in these EVs needed to be cooled only, and there was no need for too much heating. At cold temperatures (below -10°C), the energy and power capability of most batteries diminishes and EV and HEV performance diminishes. Heating systems have been used for EVs operating at colder climates. For EVs, there is no engine to aid in heating the battery pack, so the heat rejected from motor and power electronics and electricity from the battery could be used for electric heating; otherwise, a fuel-fired heater could be considered. For HEVs the heat from engine could be used, however, it takes some time (more than 5 minutes) for the engine to start warming the batteries. However, because power from the battery is needed much sooner, self-heating battery technology is an option that needs further investigation.

Cooling the batteries is a less challenging task than heating since the vehicle air conditioning/refrigerant system or engine coolant could be used. However, energy use increases with use of refrigeration, which is contrary to the HEV goal of improving fuel economy.

Series versus Parallel Air Distribution

There are two methods for distributing air to a pack for cooling and/or heating. The first method is *series* cooling, where air enters from one end of the pack and leaves from the other, exposing the same amount of air to several modules. The second method is *parallel* cooling, where the same total airflow rate is split into equal portions, and each portion flows over a single module. Depending on the size and geometry of the modules, series-parallel combination could be configured. We have found that *parallel* airflow provided a more even temperature distribution among the modules in the pack [1 and 3]. EV packs in GM EV1, Toyota RAV4-EV, Honda Insight HEV, and Toyota Prius (Japanese version) all have either series or series-parallel air distribution. The Toyota Prius (North American version) uses a pure parallel air distribution system or even temperature distribution. In parallel flow design, distributing airflow uniformly to a large battery pack will require a careful design of the air manifold.

Thermal Management for VRLA, NiMH, and Li-Ion Batteries

The relative need of the thermal management of each of the VRLA, NiMH, Li-Ion batteries depends on the heat generation rate from each type of battery, its energy efficiency, and the sensitivity of performance to temperature. From Table 1, it can be seen that NiMH batteries generate the most heat at high temperatures (>40°C) and are least efficient. At room temperature, NiMH generates less heat than VRLA and Li-Ion. The performance of a NiMH battery is more sensitive to temperature than VRLA and Li Ion batteries. Therefore, NiMH batteries need a more involved battery management control. This is also evident from various efforts to use the more effective liquid cooling for NiMH batteries. The concerns for Li Ion packs are safety and

relatively poor performance at very cold temperatures. Since Li Ion batteries can deliver much more power and thus more heat for the same volume than either VRLA or NiMH, heat removal needs to be efficient. Thermal management also depends on the type of vehicle and where the pack will be located. For EV and series HEV, the pack is generally large and its thermal management system may need to be more elaborate, possibly incorporating liquid cooling, particularly for NiMH. However, for parallel HEVs, the pack is generally smaller and the thermal control could be achieved by a simpler air cooling/heating design, especially for Li Ion and VRLA.

CONCLUSIONS

A well-designed thermal management system is required to regulate EV and HEV battery pack temperatures evenly, keeping them within the desired operating range. Production HEVs require an active heating/cooling BTMS to allow them to operate in hot and cold climates. Proper thermal design of a module has a positive impact on overall pack thermal management and its behavior. A thermal management system using air as the heat transfer medium is less complicated, though less effective, than a system using liquid cooling/heating. Generally, for parallel HEVs, an air thermal management system is adequate, whereas for EVs and series HEVs, liquid-based systems may be required for optimum thermal performance. NiMH batteries require a more elaborate thermal management system than Li Ion and VRLA batteries. Li Ion batteries also need a good thermal management system because of safety and low temperature performance concerns. The location of the battery pack may also have a strong impact on the type of battery thermal management and whether the pack should be air cooled or liquid cooled.

ACKNOWLEDGMENTS

This work was supported by DOE's Hybrid Vehicle Propulsion Program. The author wishes to acknowledge the support of DOE program manager, Bob Kost, and the NREL HEV technology manager Terry Penney. The author also appreciates the efforts of Matt Keyser and Mark Mihalic of NREL for conducting thermal characterization/evaluation of many battery modules and packs.

REFERENCES

1. Pesaran, A.A., Vlahinos, A., Burch, S.D., "Thermal Performance of EV and HEV Battery Modules and Packs," *Proceedings of the 14th International Electric Vehicle Symposium*, Orlando, Florida, December 15–17, 1997.
2. Oswald, L.J. and Skellenger, G.D. "The GM/DOE Hybrid Vehicle Propulsion Systems Program: A Status Report," *Proceedings of the 14th International Electric Vehicle Symposium*, Orlando, Florida, December 15–17, 1997.
3. Pesaran, A.A., Burch, S.D., Keyser, M., "An Approach for Designing Thermal Management Systems for Electric and Hybrid Vehicle Battery Packs," May 24-27, 1999, *Proceedings of the 4th Vehicle Thermal Management Systems*, London, UK.
4. Pesaran, A.A., Russell, D.J., Crawford, J.W., Rehn, R., and Lewis, E.A., "A Unique Calorimeter-Cycler for Evaluating High-Power Battery Modules," *Proceedings of the 13th Annual Battery Conference: Applications and Advances*, Long Beach, California, January 13–16, 1998.
5. Pesaran, A.A., Swan, D., Olson, J., Guerin, J.T., Burch, S., Rehn, R., Skellenger, G.D., "Thermal Analysis and Performance of a Battery Pack for a Hybrid Electric Vehicle," *Proceedings of the 15th International Electric Vehicle Symposium*, Brussels, Belgium, October 1–October 3, 1998.
6. Keyser, M., Pesaran, A.A., Oweis, S. Chagnon, G., Ashtiani, C. "Thermal Evaluation and Performance of High-Power Lithium-Ion Cells," in *Proceedings of the 16th International Electric Vehicle Symposium*, Beijing, China, October 1–3, 1999.
7. Pesaran, A.A., Keyser, K., "Thermal Characteristics of selected EV and HEV Batteries," *Proceedings of the 16th Annual Battery Conference: Applications and Advances*, Long Beach, California, January 9–12, 2001.
8. Keyser, M., Pesaran, A.A., Mihalic, A., and Zolot, M., "Thermal Characterization of Advanced Battery Technologies for EV and HEV Applications," *NREL Report*, August 2000.